

6427525 N E C ELECTRONICS INC

05E 22772 D

**BIPOLAR ANALOG INTEGRATED CIRCUIT**

**$\mu$ PC1238V,  $\mu$ PC1238H**

**10 W AF POWER AMPLIFIER**

T-74-05-01

The  $\mu$ PC1238 is an audio power amplifier designed for median Hi-Fi stereo set and TV set sound power amplifier. This device can provide 8.4 watts to 8 ohm at 1 % T.H.D. and  $\pm 13$  V supply voltage. The  $\mu$ PC1238 incorporates the thermal protection circuit to protect the damage of IC chip against load damping etc. Since the package is a 5 Pin TO-220 package, it greatly simplifies construction of a power amplifier both in design and assembly.

**FEATURES**

- High output power
  - 8.4 W TYP. (at 8  $\Omega$ ,  $V_{CC} = \pm 13$  V)
  - 12.5 W TYP. (at 4  $\Omega$ ,  $V_{CC} = \pm 13$  V)
- Low T.H.D.
  - 0.012 % TYP. ( $P_{out} = 2$  W,  $R_L = 8 \Omega$ )
  - 0.02 % TYP. ( $P_{out} = 2$  W,  $R_L = 4 \Omega$ )
- Low equivalent input noise voltage.
- Available for NFB tone control mode.
- Negligible power ON/OFF noise.
- High density components assembly due to 5 Pin TO-220 package.

**CONNECTION DIAGRAM**

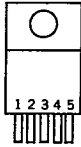

Pin No.	Electrical Connection
1	Non inverting input
2	Inverting input
3	-VCC
4	Output
5	+VCC

**PACKAGE DIMENSIONS (Unit: mm)**

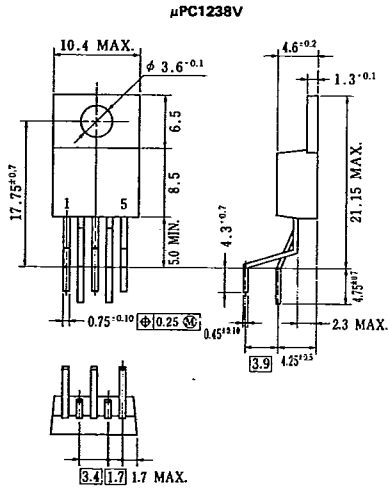

PSVP-146B2

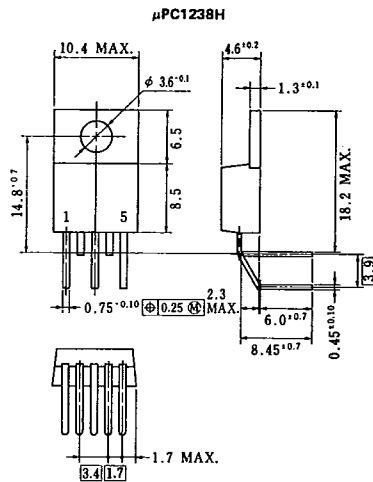

PSVP-146B1

**μPC1238V, μPC1238H**  
05E 22773 D

6427525 N E C ELECTRONICS INC

*T-74-05-01*

**ABSOLUTE MAXIMUM RATINGS (T<sub>a</sub> = 25 °C)**

Supply Voltage (Quiescent)	V <sub>CC</sub>	±18	V
Supply Voltage (Operational)	V <sub>CC</sub>	±15	V
Circuit Current	I <sub>CC(peak)</sub>	4	A
Package Dissipation	P <sub>D</sub>	*25	W
Junction Temperature	T <sub>j</sub>	150	°C
Operating Temperature	T <sub>opt</sub>	-20 to +65	°C
Storage Temperature	T <sub>stg</sub>	-40 to +150	°C
Thermal Resistance Junction to Case	R <sub>th(j-c)</sub>	3.4	°C/W

\*T<sub>tab</sub> = 65 °C

**RECOMMENDED OPERATING CONDITIONS (T<sub>a</sub> = 25 °C)**

CHARACTERISTIC	SYMBOL	MIN.	TYP.	MAX.	UNIT
Operating Supply	V <sub>CC</sub>	±6	±13	±15	V
Terminated Input Resistance	R <sub>IN</sub>	47	56	100	kΩ
Closed Loop Voltage Gain	A <sub>v</sub>	20	35		dB
Load Impedance	R <sub>L</sub>	4	8		Ω

**ELECTRICAL CHARACTERISTICS**

(Refer to the test circuit : T<sub>a</sub> = 25 °C, V<sub>CC</sub> = ±13 V, A<sub>v</sub> = 35 dB, R<sub>G</sub> = 600 Ω, R<sub>L</sub> = 8 Ω)

CHARACTERISTIC	SYMBOL	MIN.	TYP.	MAX.	UNIT	TEST CONDITIONS
Output Offset Voltage	V <sub>OFF</sub>	-100	0	+100	mV	No Signal
Circuit Current	I <sub>CC</sub>	30	60	130	mA	No Signal
Output Power	P <sub>O</sub>	7	8.4		W	T.H.D. = 1 %, f = 1 kHz
Total Harmonic Distortion	T.H.D.		0.2	1	%	f = 40 Hz - 15 kHz P <sub>O</sub> = 0.1 - 7 W
Open Loop Voltage Gain	A <sub>vo</sub>		83		dB	P <sub>O</sub> = 0.1 W, f = 500 Hz
Equivalent Input Noise Voltage	V <sub>NI</sub>		3	10	μV <sub>r.m.s.</sub>	R <sub>G</sub> = 2.2 kΩ f = 40 Hz - 15 kHz (-3 dB)
Power Band Width	P.B.W.		75		kHz	P <sub>O</sub> = 0.1 W, -3 dB
Supply Voltage Rejection Ratio	S.V.R.	45	51		dB	f = 100 Hz, R <sub>G</sub> = 2.2 kΩ

5

**μPC1238V, μPC1238H**  
**6427525 N E C ELECTRONICS INC**

05E 22774 D

TEST CIRCUIT & TYPICAL APPLICATIONS

T-74-05-01

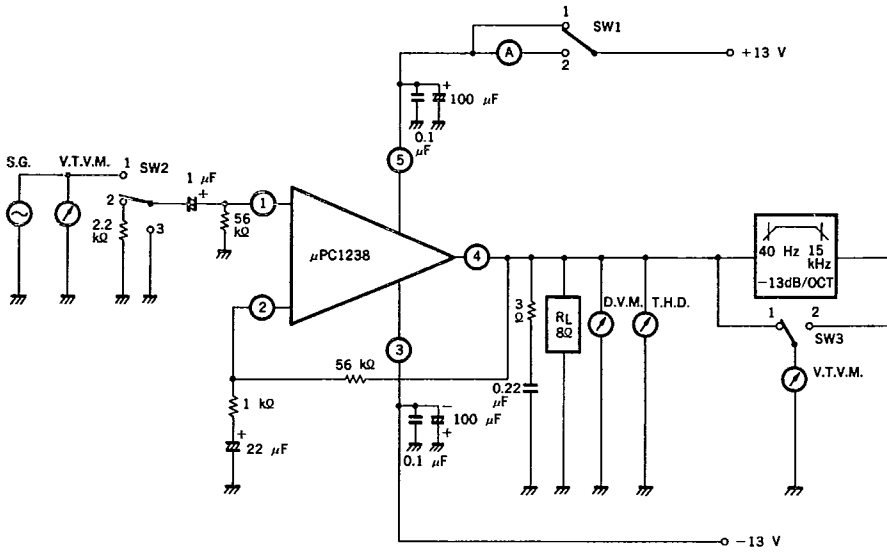

Switch Position

TEST ITEM	SYMBOL	SW1.	SW2.	SW3.
Output Offset Voltage	V <sub>OFF</sub>	1	3	1
Circuit Current	I <sub>CC</sub>	2	3	1
Output Power	P <sub>O</sub>	1	1	1
Total Harmonic Distortion	T.H.D.	1	1	1
Equivalent Input Noise Voltage	V <sub>NI</sub>	1	2	2
Supply Voltage Rejection Ratio	S.V.R.	1	2	1

6427525 N E C ELECTRONICS INC

$\mu$ PC1238V,  $\mu$ PC1238H  
05E 22775 D

T-74-05-01

TYPICAL CHARACTERISTICS ( $T_a = 25^\circ\text{C}$ )

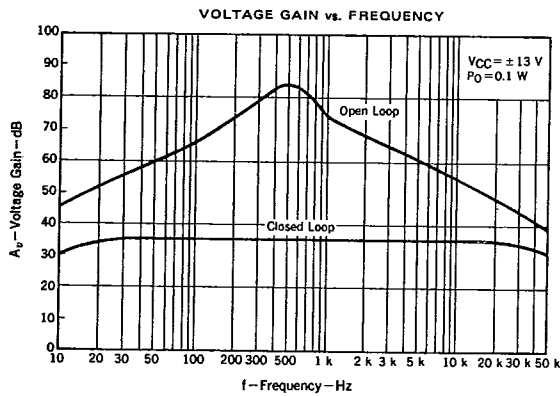
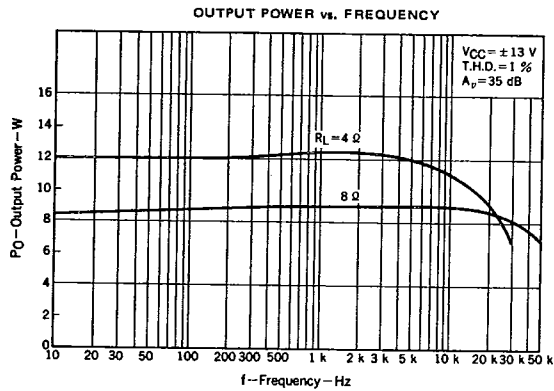
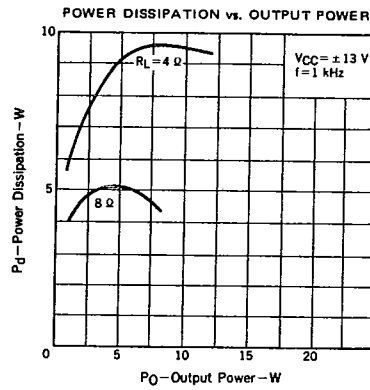
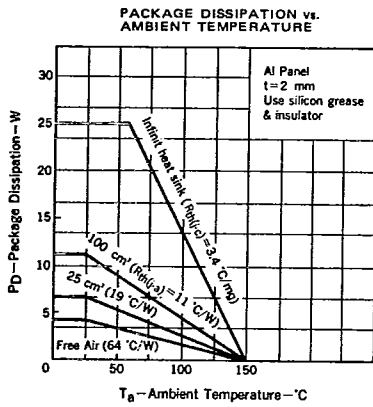

5

$\mu$ PC1238V,  $\mu$ PC1238H  
6427525 N E C ELECTRONICS INC

05E 22776 D  
T-74-05-01

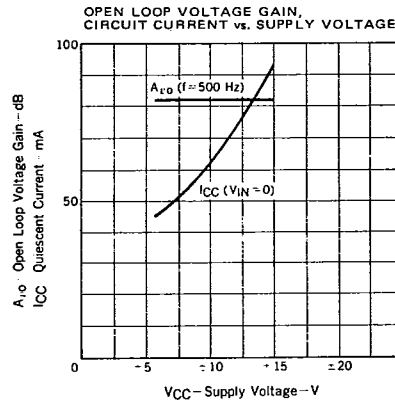
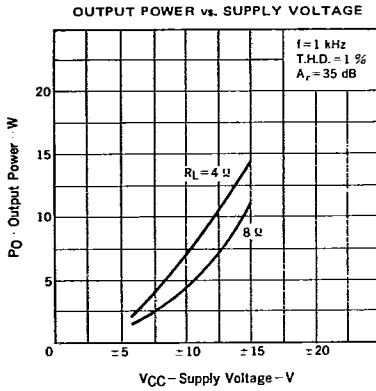
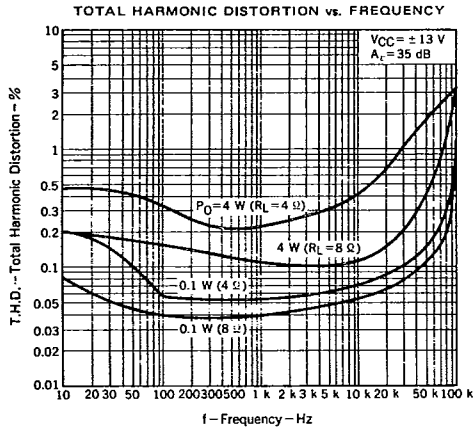
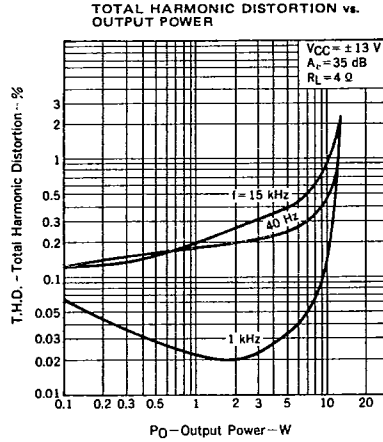
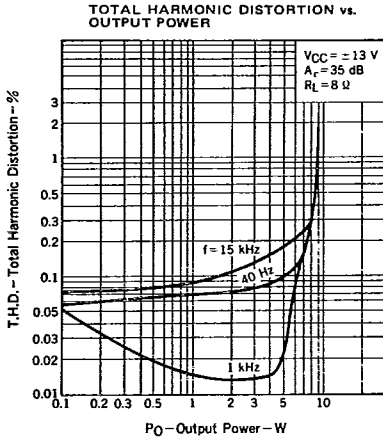

6427525 N E C ELECTRONICS INC

$\mu$ PC1238V,  $\mu$ PC1238H  
05E 22777 D

T-74-05-01

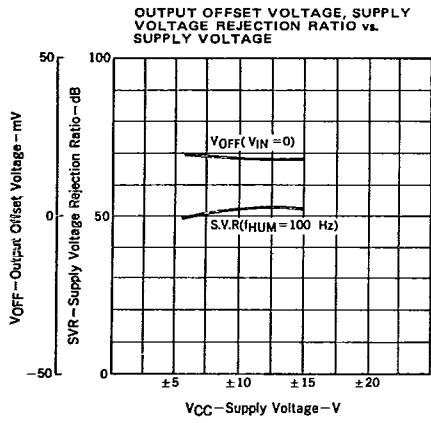

5